



---

## Ready 8S

---



---

# Table of Contents

<b>Introduction</b> .....	2
Purpose of this manual.....	2
Disclaimer.....	2
Data for ordering spare parts.....	2
Specially approved products.....	2
Qualification of personnel.....	2
Dimensional accuracy inspection.....	2
<b>Product Description</b> .....	3
The data plate.....	3
Product denomination.....	3
<b>Spare Parts</b> .....	5
Exploded view.....	5
List of parts.....	6

# Introduction

## Purpose of this manual

The purpose of this manual is to provide necessary information on spare parts and accessories order.

## Disclaimer

Always use genuine Flygt parts. The use of other spare parts or accessories can invalidate any claims for warranty or compensation. Xylem does not take any responsibility for damages caused by the use of non-original parts. For more information, contact your Xylem representative.

## Data for ordering spare parts

The following information is needed for spare part orders:

- Serial number of the product
- Part number
- Quantity (\* specify piece goods)

## Specially approved products

### Qualification of personnel

Only Xylem or Xylem-authorized service personnel may undertake repair work on Ex-approved products.

### Dimensional accuracy inspection

Spare parts marked with (EX) after the part number are subject to dimensional accuracy inspection.

# Product Description

## The data plate

### Introduction

The data plate is located on the main body of the pump. The data plate lists key product specifications.

### The data plate

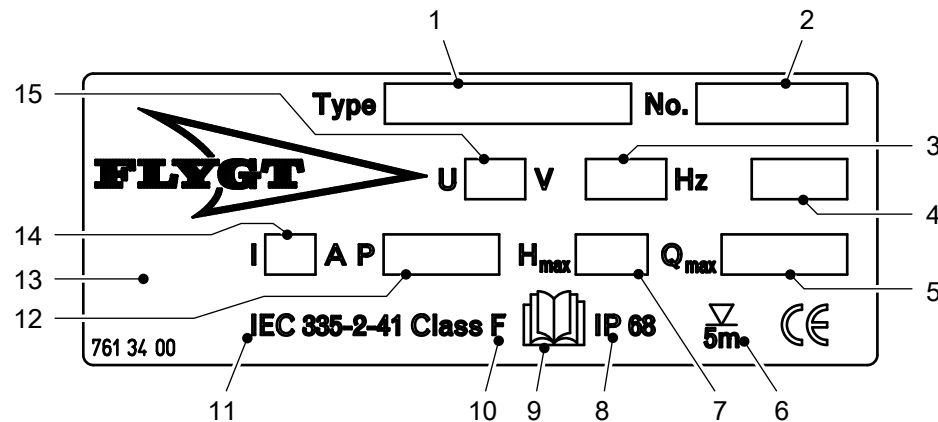

1. Pump model
2. Serial number
3. Phase; type of current; frequency
4. Product weight
5. Maximum capacity
6. Maximum submergence
7. Maximum head
8. Degree of protection
9. Read installation manual
10. Thermal class
11. International standard
12. Rated shaft power
13. Country of origin
14. Rated current
15. Rated voltage

## Product denomination

### Sales denomination

The sales denomination consists of the four-digit sales code and two letters that indicate the hydraulic end and type of installation.

This is an example of a sales denomination, and an explanation of its parts.

NP 3085

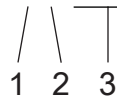

1. Hydraulic part
2. Installation type
3. Sales code

### Product code

The product code consists of nine characters divided into two parts.

This is an example of a product code, and an explanation of its parts.

NP 3085.183

1

2

1. Sales denomination
2. Version

### Serial number

The serial number is used for identification of an individual product, and is divided into four parts.

This is an example of a serial number, and an explanation of its parts.

NP 3085.183 - 951 0163

1

2

3

4

1. Product code
2. Production year
3. Production cycle
4. Running number

# Spare Parts

## Exploded view

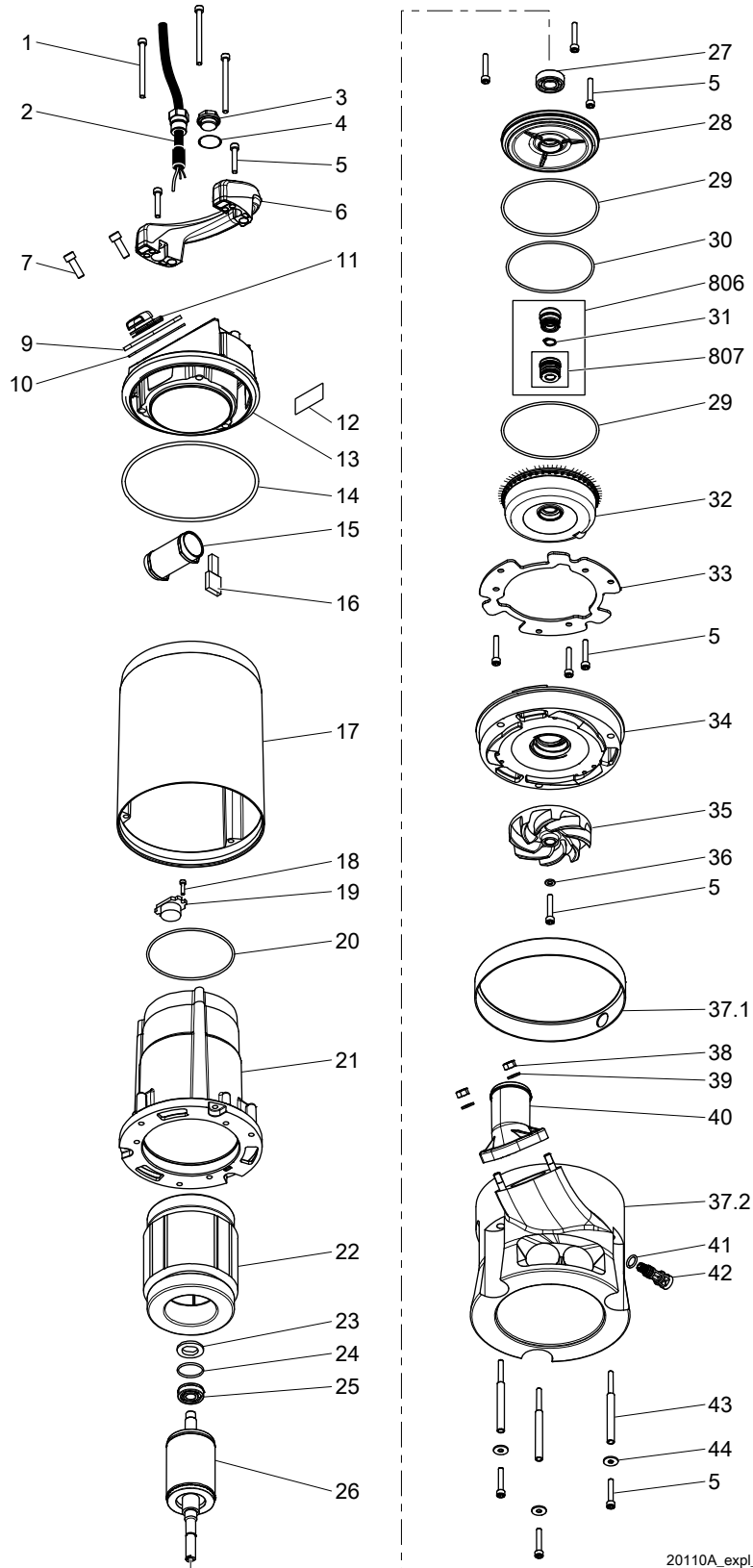
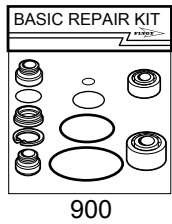
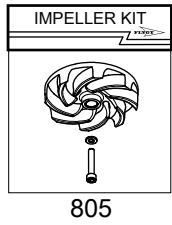
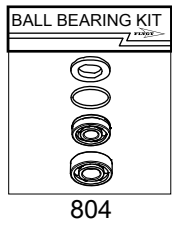
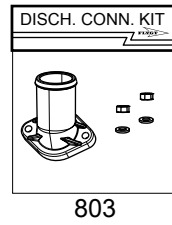
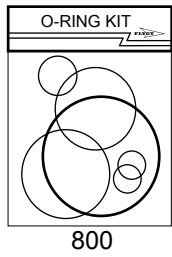

20110A\_expl\_view\_2008.281

## List of parts

Pos. No	Part. No	Denomination	Qty/Version
			281
1	81 65 45	Hex.socket hd screw M6X80-A2-70	3
2	761 03 00	Motor cable unit 532.1U+H07RN-F 3X1 MM2	1
2	761 03 01	Motor cable unit S00W-16AWG/3 115V USA CDN	1
2	761 03 02	Motor cable unit H07RN-F 3X1 MM2 230V GB	1
2	761 03 03	Motor cable unit H07RN-F 3X1 MM2 230V AUS	1
2	761 03 04	Motor cable unit H07RN-F 3X1 MM2 110V GB	1
2	761 03 05	Motor cable unit SOW-16AWG/3 230V USA CDN	1
2	761 03 06	Motor cable unit H07RN-F 3X1 MM2 CH	1
3	761 05 00	Plug	1
4	82 76 96	O-ring 20.0X2.0 NBR	1
5	82 00 19	Hex.socket hd screw M6X35-A2-70	12
6	760 58 00	Handle	1
7	82 00 32	Hex.socket hd screw M8X20-A2-70	2
9	83 18 24	Coupling part DN 52 INNER G2B STORZ	1
10	713 08 00	Gasket	1
11	767 20 00	Valve unit	1
12	761 34 00	Data plate	1
13	760 57 00	Cover	1
14	82 74 83	O-ring 149.3X5.7 NBR	1
15	84 11 80	Capacitor 14 MFD 450V	1
15	84 11 81	Capacitor 30 MFD 275V	1
15	84 11 82	Capacitor 35 MFD 275V	1
16	83 44 11	Terminal device 48X12X6 MAX.380V 18A	1
16	83 44 12	Terminal device 54X21X8.5 MAX.380V 18A	1
17	760 56 00	Cooling jacket	1
18	81 99 86	Hex.socket hd screw M4X16-A2-70	1
19	84 03 27	Motor switch 115V 50HZ	1
19	84 03 28	Motor switch 230V 50HZ	1
19	84 03 30	Motor switch 115V 60HZ	1
19	84 03 33	Motor switch 230V 60HZ	1



Pos. No	Part. No	Denomination	Qty/Version
			281
20	82 74 73	O-ring 99.5X3.0 NBR	1
21	760 55 00	Stator housing	1
22	690 42 01	Stator 12-08-2b	115V.
22	690 42 02	Stator 12-08-2b	230V - 240V.
23	82 56 23	Spring washer 31.5X25X0.35	1
24	82 77 19	O-ring 26.0X1.2 NBR	1
25	83 51 47	Ball bearing 12X32X10	1
26	761 02 01	Shaft unit	1
27	83 32 42	Ball bearing 15X35X11	1
28	761 54 00	Bearing housing	1
29	82 74 76	O-ring 114.5X3.0 NBR	2
30	82 74 74	O-ring 104.5X3.0 NBR	1
31	82 60 84	Retaining ring	1
32	561 48 01	Oil housing	1
33	761 56 00	Washer	1
34	561 54 00	Wear protection	1
35	712 84 00	Impeller	50 Hz.
35	712 84 02	Impeller	60 Hz.
36	82 37 09	Plain washer	1
37	701 31 00	Pump housing unit	1
37.1	702 69 00	Supporting ring	1
37.2	702 68 00	Pump housing	1
38	82 23 32	Hexagon nut M8-A4-70	2
39	82 35 16	Plain washer 8-A2-A-170	2
40	708 99 00	Discharge connection 2"	1
40	708 99 01	Discharge connection NPSM 2"	1
40	708 99 02	Discharge connection G2"	1
41	82 73 82	O-ring 10.3X2.4 NBR	1
42	770 12 00	Inspection screw	1
43	760 59 00	Barrel nut	3
44	82 37 93	Plain washer 9021-6,4X18X1,6	3
800	769 66 00	O-ring kit	Contains all position numbered O-rings.
803	714 85 00	Discharge conn. kit 2"	1
803	714 85 01	Discharge conn. kit NPSM 2"	1
803	714 85 02	Discharge conn. kit G2"	1
804	618 17 00	Ball bearing kit	1
804.1	82 56 23	Spring washer 31.5X25X0.35	1
804.2	82 77 19	O-ring 26.0X1.2 NBR	1

## Spare Parts

Pos. No	Part. No	Denomination	Qty/Version
			281
804.3	83 32 42	Ball bearing 15X35X11	1
804.4	83 51 47	Ball bearing 12X32X10	1
805	769 69 00	Impeller kit	50 Hz.
805	769 69 01	Impeller kit	60 Hz.
806	618 16 00	Seal kit COMPLETE	1
807	621 02 00	Outer seal kit	1
910	761 32 00	Level regulator kit EU	1
910	761 32 01	Level regulator kit CSA UL	1



# Xylem |'zīləm|

- 1) The tissue in plants that brings water upward from the roots
- 2) A leading global water technology company

We're 12,500 people unified in a common purpose: creating innovative solutions to meet our world's water needs. Developing new technologies that will improve the way water is used, conserved, and re-used in the future is central to our work. We move, treat, analyze, and return water to the environment, and we help people use water efficiently, in their homes, buildings, factories and farms. In more than 150 countries, we have strong, long-standing relationships with customers who know us for our powerful combination of leading product brands and applications expertise, backed by a legacy of innovation.

For more information on how Xylem can help you, go to [xylem.com](http://xylem.com)



Xylem Water Solutions AB  
Gesällvägen 33  
174 87 Sundbyberg  
Sweden  
Tel. +46-8-475 60 00  
Fax +46-8-475 69 00  
<http://tpi.xylem.com>

Visit our Web site for the latest version of this document and more information

The original instruction is in English. All non-English instructions are translations of the original instruction.

© 2011 Xylem Inc